



SILVACO

Display Design and Development Solutions

Leader in Display Technology Development

Agenda

- Silvaco Background
- Display Technologies
 - Market, R&D Drivers
 - Challenges and Solutions
 - Silvaco Success in Display Technologies
- Silvaco Solutions for Display Technologies
 - Flow Overview
 - Technology Development
 - Design and Verification

Silvaco at a Glance

Enabling semiconductor innovation from atoms to systems

Design, Simulate, Analyze, and Verify
from Concept to Complete Product Yield

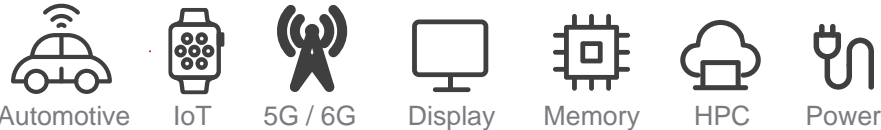
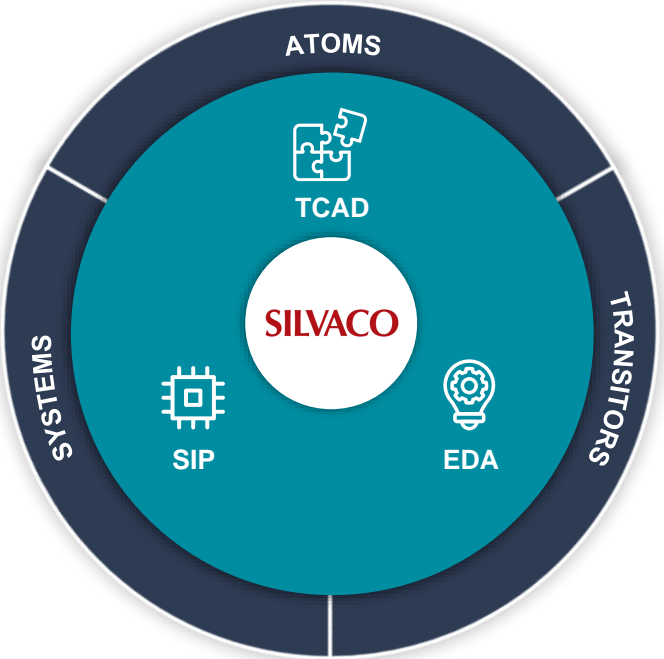

Silvaco Leadership

8 of 10⁽¹⁾
Largest Display
Companies Use
Silvaco's TCAD

600+
Customers

6 of 10⁽²⁾
Largest Semiconductor
Companies Use
Silvaco's EDA

200+
University Customers

260+
Employees

Global Presence

Headquarters &
Development Center
Silicon Valley, USA

- Sales Offices
- R&D Centers
- Sales/R&D Centers



1) Largest in terms of revenue from Q2'2020 to Q2'2022 according to DSCC.
2) Largest in terms of 2021 revenue according to IC Insights.

Display Device Technology

Market, R&D Drivers

Differing Design Goals

— TV/Monitor — Phone — AR — VR — Info Display

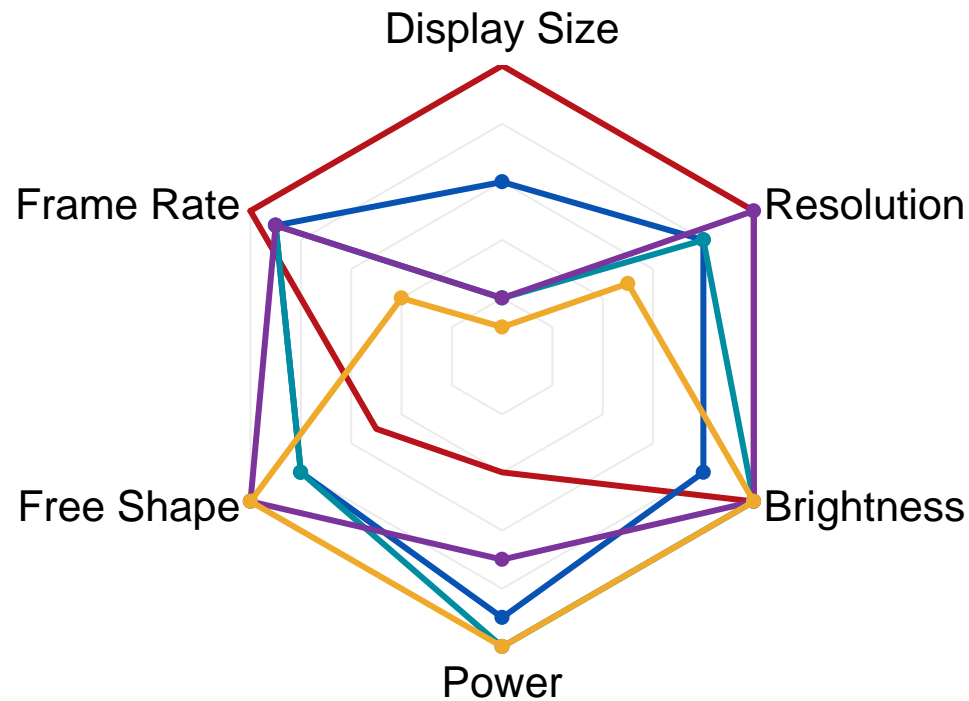

Feature	TV / Monitor	Phone	AR	VR	Info Display
Resolution	4K (3840X2160) 8K (7680X4320)	458PPI (1284X2778) 421PPI (2400X1080)	720P (1280X720 px) Aspect ratio :16:9	WUXGA (1920X1200)	~304 X 256
Active Area	2000mm X 1500 mm	78 mm X 160mm	14.1mm X 7.92mm	21.1mm X 13.2mm	3.65mm X 3.07mm
Display Inch	60"~100"	5.4" ~ 6.7"	0.64"	1"~1.5"	0.19"
Frame Rate	60Hz ~240Hz	60Hz~120Hz	Up to 120Hz	Up to 120Hz	Up to 20Hz
Typ/Max Current	T: 35mA/cm ² M : 3A/cm ²	T: 25mA/cm ² M : 2A/cm ²	T: 25mA/cm ² M : 1.8A/cm ²	T: 25mA/cm ² M : 2A/cm ²	T: 25mA/cm ² M : 1.3A/cm ²
Power	>200mW (@300 cd/m ²)	200mW (@300 cd/m ²)	160mW (@300 cd/m ²)	200mW (@300 cd/m ²)	1~3mW (@300 cd/m ²)

Display Device Technology

Market, R&D Drivers

- New substrate technologies, as well as integrated sensors
 - Flexible and stretchable substrates
 - Optical sensors for biometric authorization
- Automotive: Driver Assist Heads Up Displays, Immersive Infotainment systems
- Augmented Reality (AR) and Virtual Reality (VR) are rapidly growing consumer and industrial markets, bring new challenges to display performance
- Specific end-application focus needed to develop display technology and display designs to meet the specific needs of these evolving markets

Display Device Technology

Market, R&D Drivers

- “Metaverse” driving lots of attention on VR / AR / MR but with many challenges
 - How to create a virtual reality space so advanced that the difference from reality is unrecognizable
 - Requires high resolution, good uniformity, wide viewing angle, high contrast, wide color gamut, and novel optics
- uLED / uOLED displays deliver distinct advantages over traditional LCD solutions, and are key to delivering high luminance and contrast in Automotive, AR / VR, and other applications
- Backplane technologies that maximize help to achieve high resolution and low power consumption

Challenges and Silvaco Solutions

Challenges

- Physics-Accurate Design, requires co-design and/or short learning loops

Technology & Design Coordination

- LTPS and IGZO TFTs
- μ OLED, μ LED, Quantum Dot
- Flexible Substrates

New Materials and Devices

- Dynamic Refresh Rates
- Dense Pixels Per Inch
- High Contrast, High Luminance

Expanded Performance Specifications

- Image Retention Issues
 - Hysteresis Effects
 - Mechanical Stress Effects

Reliability / Degradation Mechanisms

- Disruptive technologies must meet market timing, while

Development Cost / Time To Market

Silvaco Solutions

Industry's Only Complete Offering

- TCAD for Device Physics
- SPICE modeling
- Simulation, design, and layout

2D/3D TCAD Solution

- Materials, Models, and Features required for Physics-Accurate Device Technology Development

Technology Physics integrated into Pixel Design

- Mixed Mode incorporates TCAD physics accuracy into SPICE functional circuit design

Physics and Functionality to Empower Engineers

- TCAD and SPICE Models with Target Physics
- SPICE functionality to capture application-specific behavior

Industry leader in Display Development

- Integrated tools, Industry Proven
- Experienced support team with expertise supporting leading display manufacturers

Silvaco Leadership

Display – Technology Development and Design

- Adopted at industry leaders
 - Only vendor offering complete flow, including TCAD and SPICE Modeling, to the Display industry
- Hundreds of customers, using Silvaco Solutions for Display Technology Development and Display Design
 - Supported by responsive and knowledgeable FAE team
- Deep collaboration with research and academia to develop tools for new and emerging technologies
- Agile R&D team to respond to unique customer requirements

SILVACO vs. Competition

- Silvaco
- Competitor #1
- Competitor #2
- Competitor #3

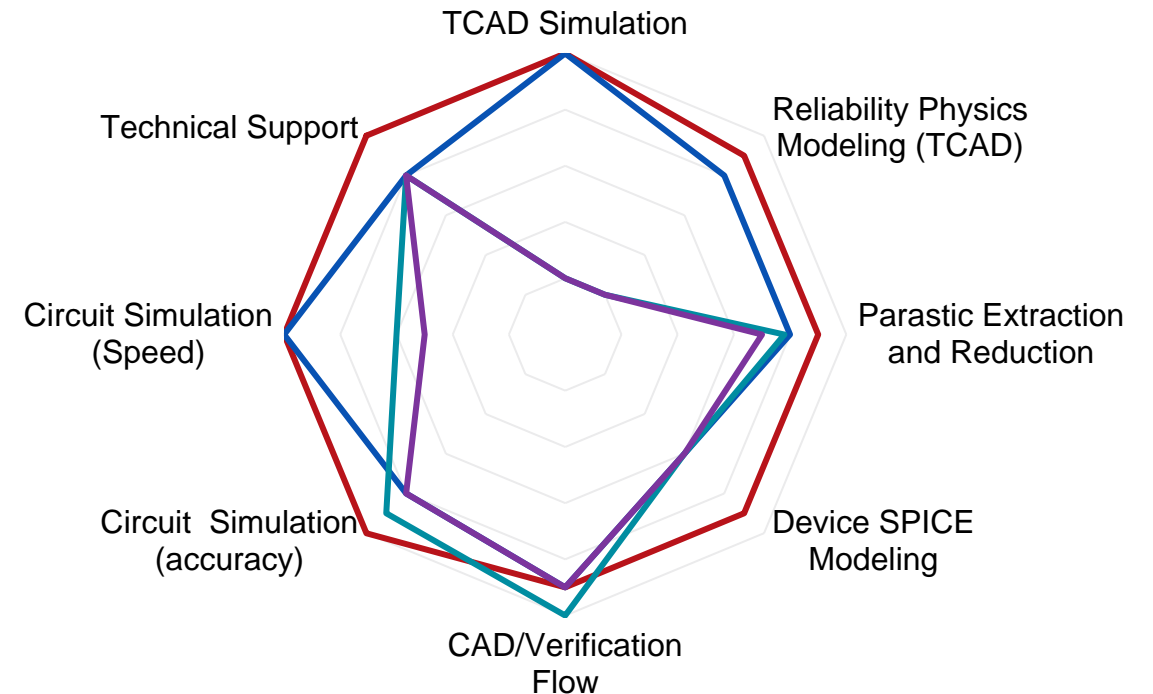

Customer Testimonials

Silvaco Tools Enable Innovation for Display Development

“Due to Silvaco’s product lineup and technical support, we can look forward to a high total performance for future OLED design and development ...”

“In the design and development of high-quality liquid crystal displays pursued by Sharp Display Devices Company, a fast and highly accurate simulation environment is essential. Due to Silvaco’s product lineup and technical support, we can look forward to a high total performance for future OLED design and development as well”.

**Noboru Matsuda, Deputy General Manager
Sharp Display Device Company**

“We chose Silvaco for their complete extraction solution for TFT sensors ...”

“Trixell builds displays for X-ray imaging, and we have demanding performance-driven feature and manufacturing requirements. We chose Silvaco for their complete extraction solution for TFT sensors, which is reliable, consistent, and well-supported. Our prior toolset was a collection of point tools that did not meet our requirements for consistent analysis and product support. The technical team at Silvaco has been excellent and quickly brought up our new analysis flow”.

**Simon Marecaux, Design Leader
Trixell**

Silvaco – Display Solutions

Flow Overview

Silvaco solutions cover all stages of the display development and design process

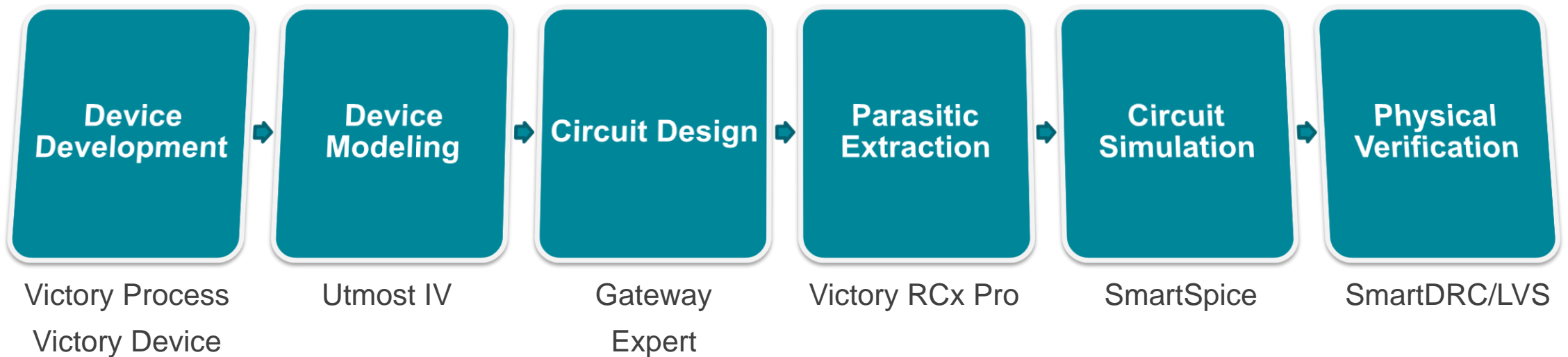

Display Development

From Concept to Foundry

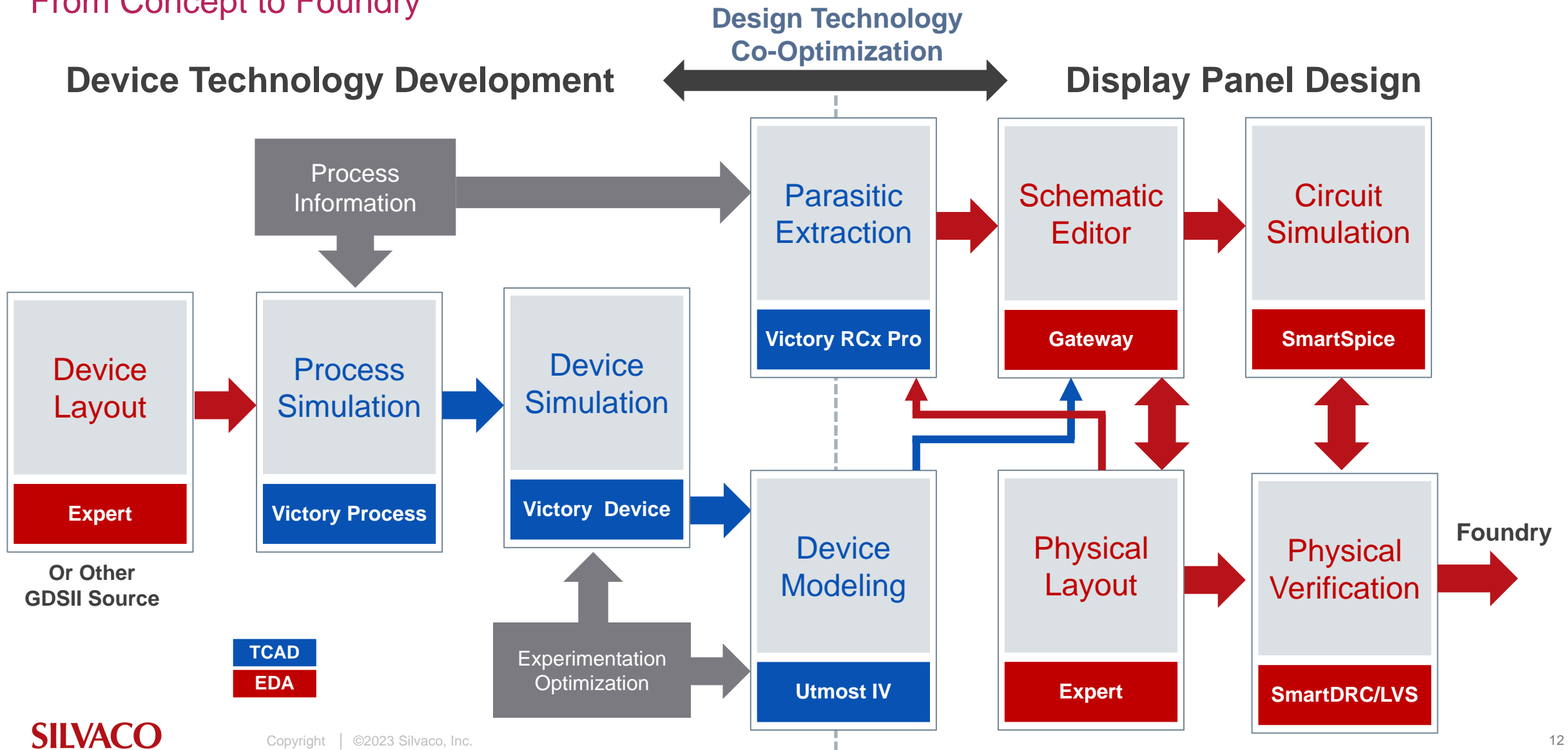

Display Development

Solving Technology + Design Issues

Examples requiring TCAD physics-based simulations

- Reliability issues (e.g., aging, hysteresis effects)
- Physical design issues (e.g., cross talk)
- Process change, device variability, new materials

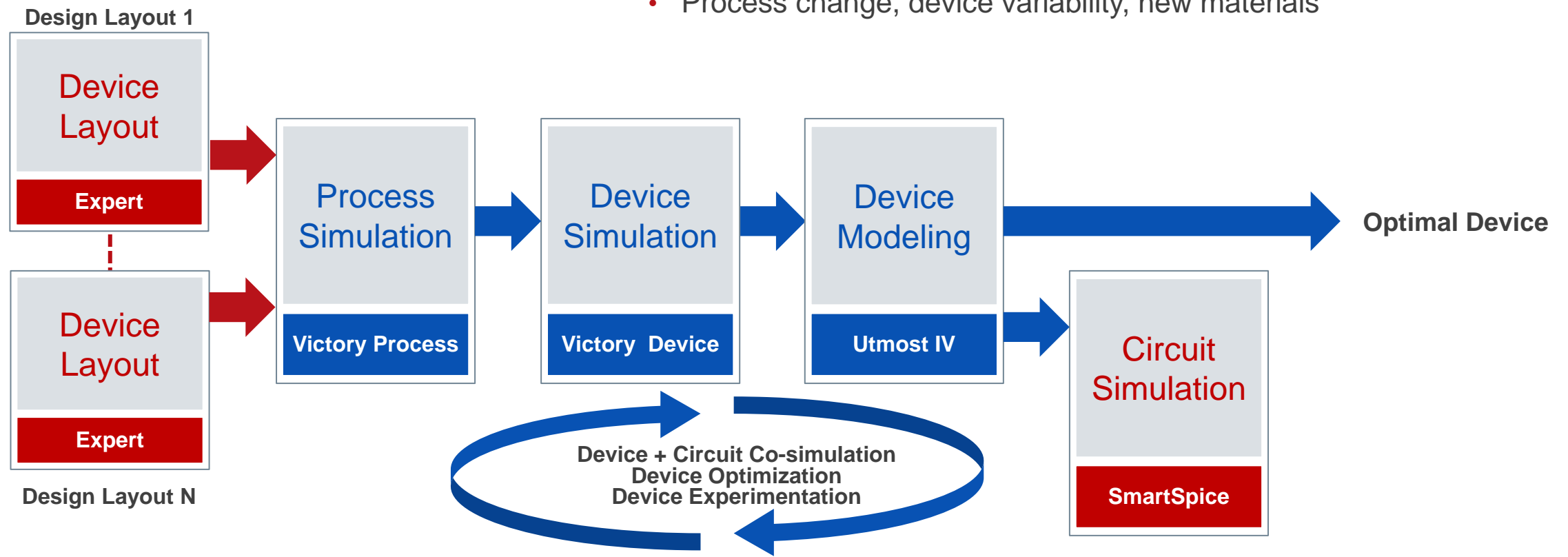

Technology Development

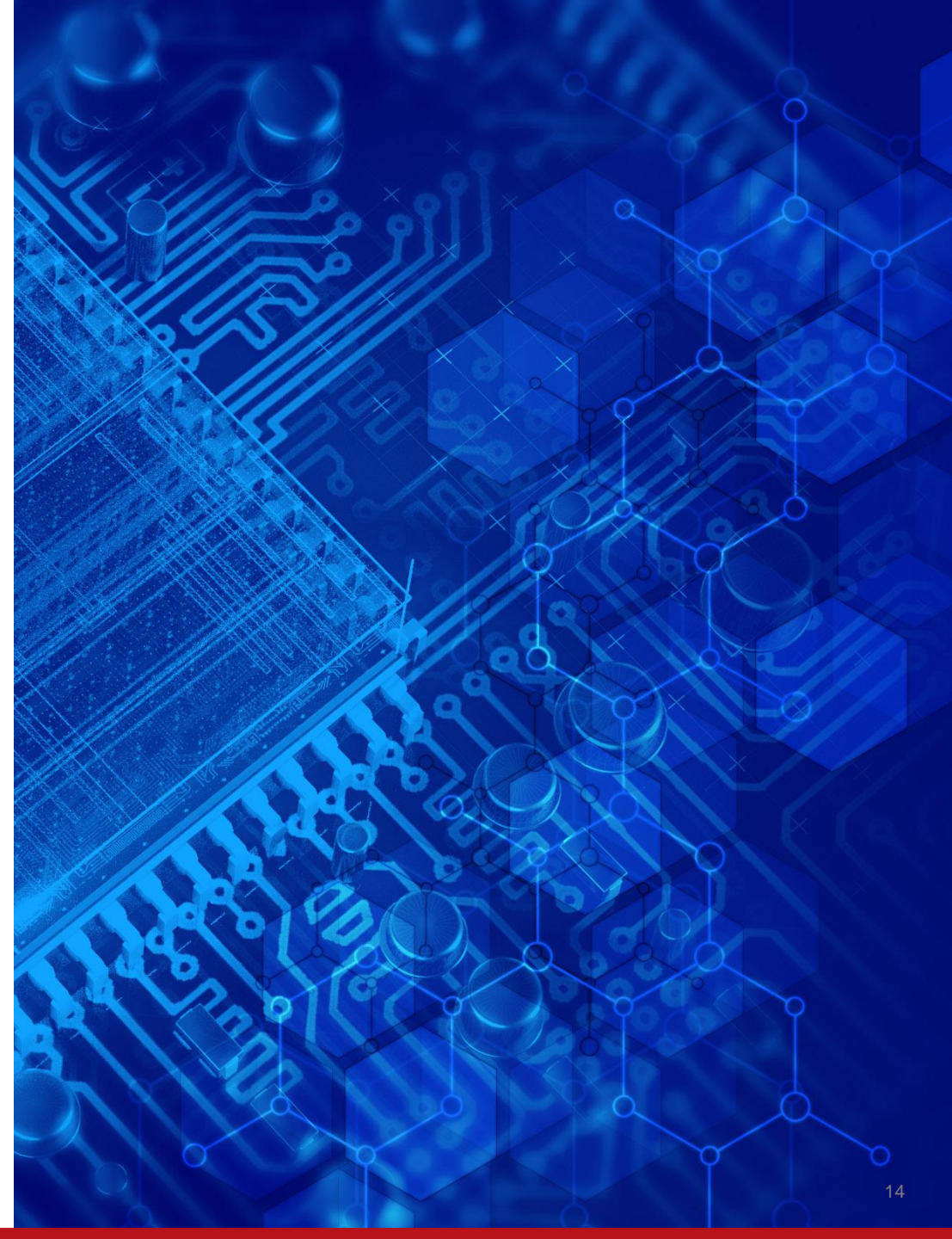

Backplane Technology Development

Physics-Accurate Process and Device TCAD

- Complete coverage for multiple transistor types
 - a-Si TFT, poly-Si TFT, Oxide TFT, Bulk CMOS
- Various types of simulation conditions
 - Temperature, illumination
 - Electrical Stress and Aging
 - Mechanical (Bending) stress
 - Manufacturing process (Grain effects, Hydrogen effects, etc.)
- Physics model for TFTs
 - Drift / Diffusion Simulation
 - Bump / tail density of states modeling
 - Mobility models specific to poly-Si and amorphous materials

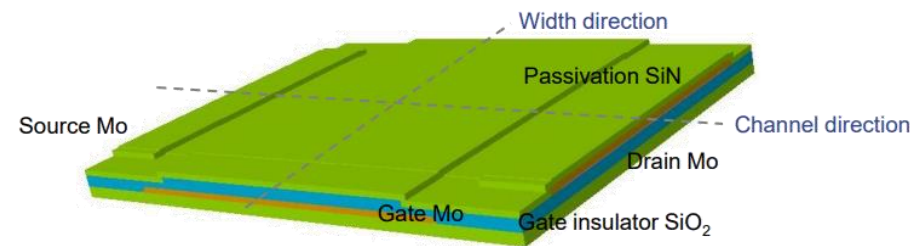
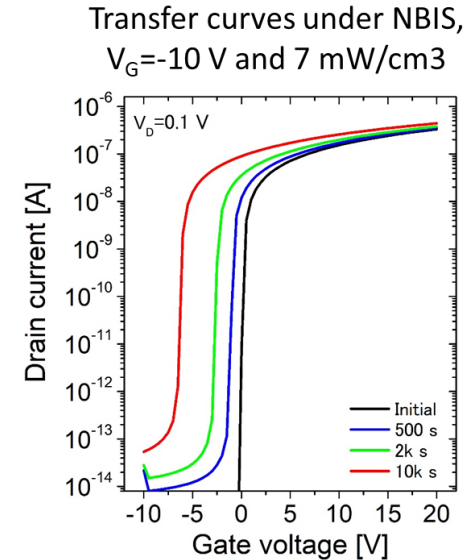

Victory Process (process mode) - Export Stress Mesh
Data from tfex11_bending3d.str

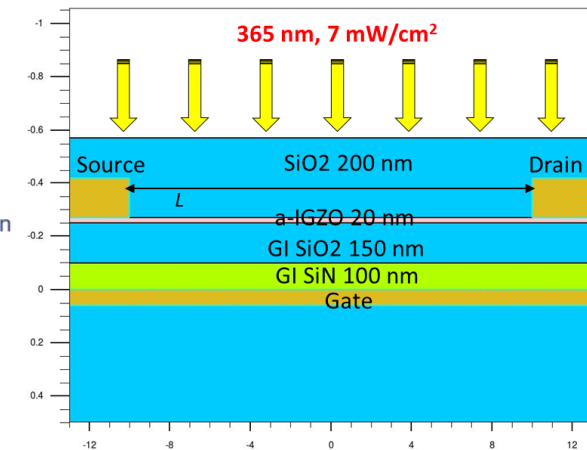
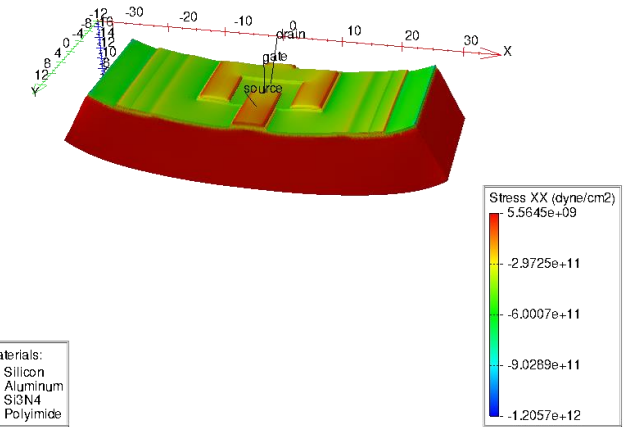

Frontplane Technology Development

Physics-Accurate Process and Device TCAD

- OLED, LCD, MicroLED
- 2D/3D Structure
- OLED Physics
 - Density of States Modeling, Drift-Diffusion/Poole-Frenkel mobility model, Bimolecular Langevin Recombination, Exciton Rate equation: single/triplet exciton profiles, Radiative rate for luminescence or phosphorescence
- LCD Electrical/Optical Simulation
- Reverse Ray Tracing
 - External efficiency, Angular power plot, Optical output coupling, Near and far field patterns

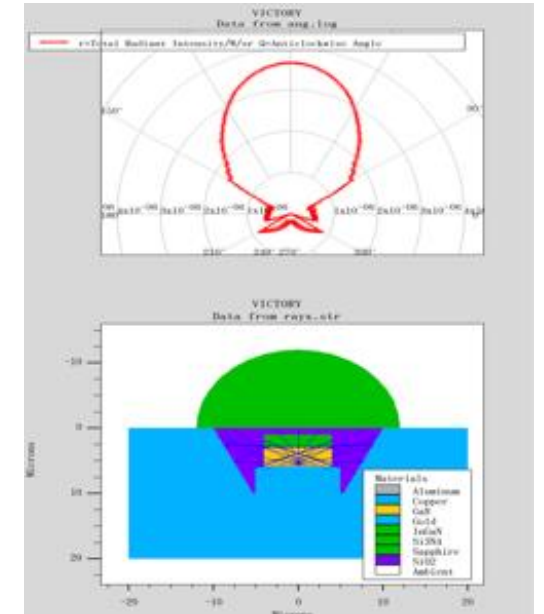
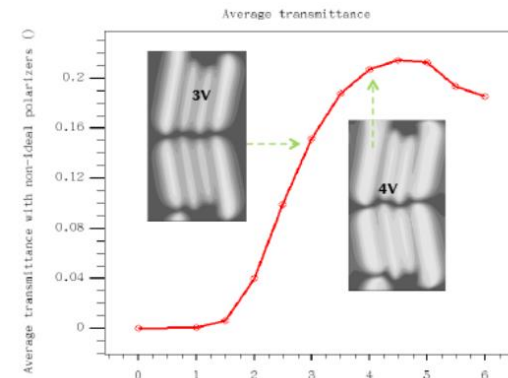
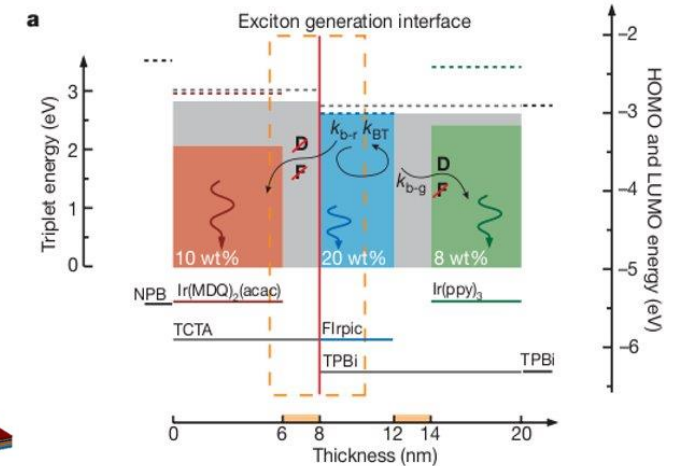
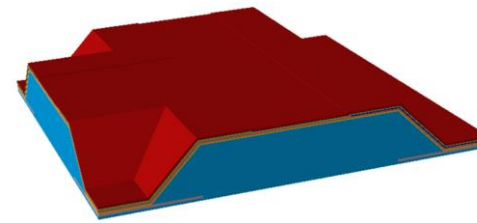
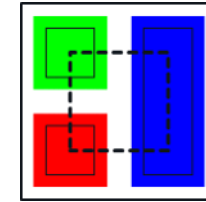

Co-Design of Device Technology and Circuit - MixedMode Simulation

TCAD Physics-based TFT and OLED Simulation Coupled with SPICE Circuit Simulation

Physics-based devices are used when accurate compact models do not exist, or when high accuracy device physics is required

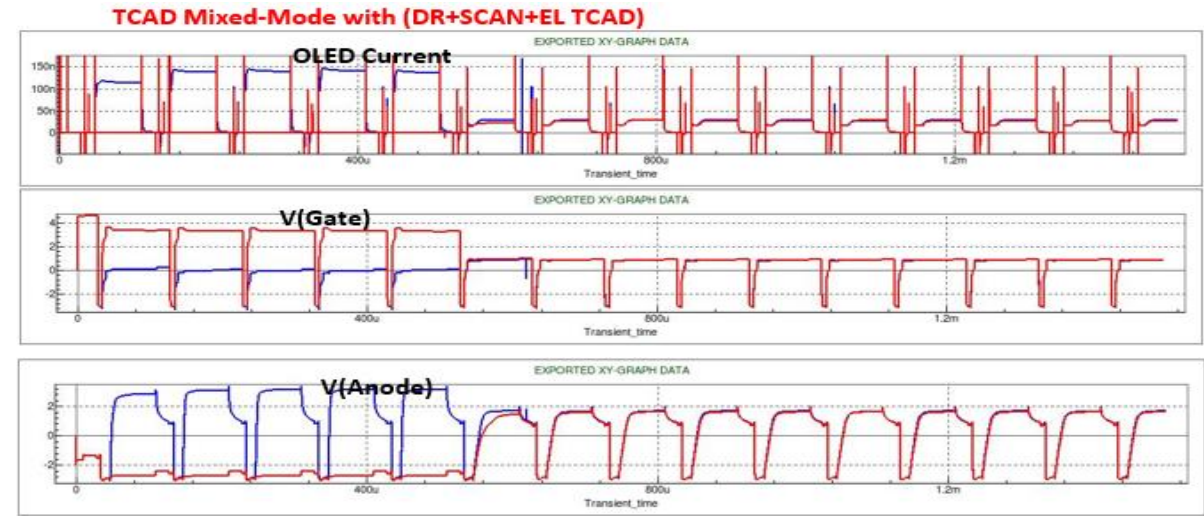
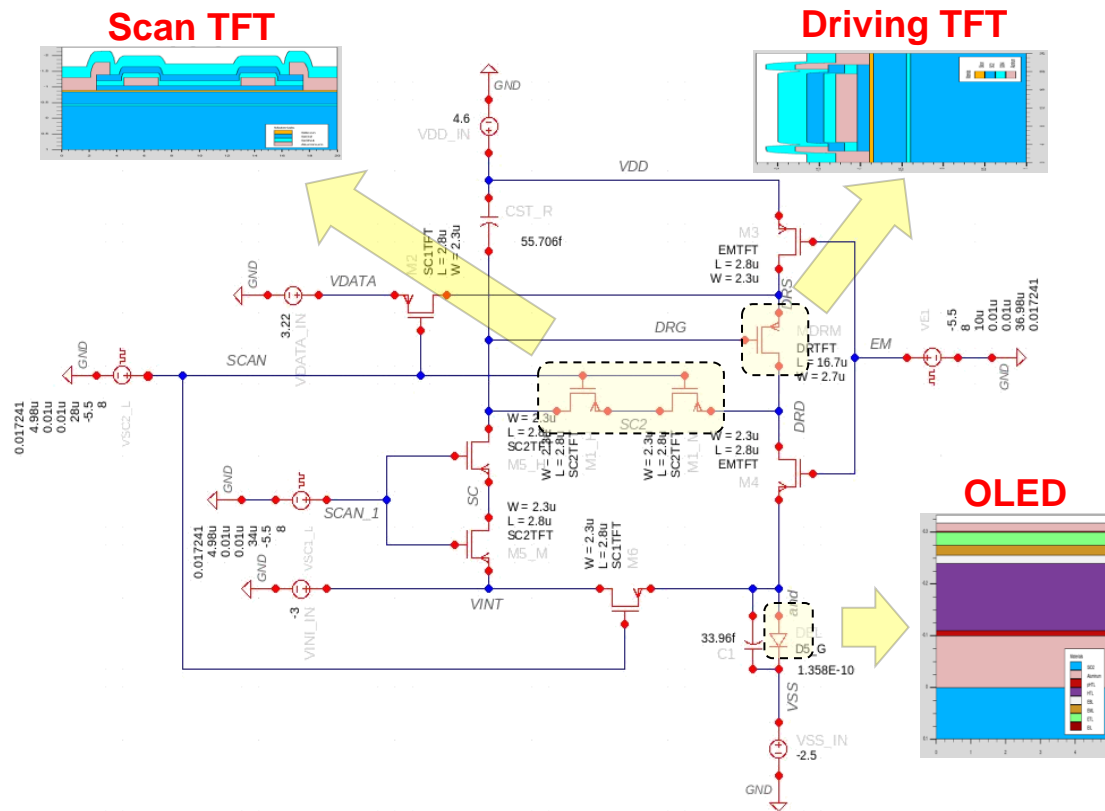

Red Color: 5 frames Dark and 10 frames Gray Blue Color: 5 frames White and 10 frames Gray

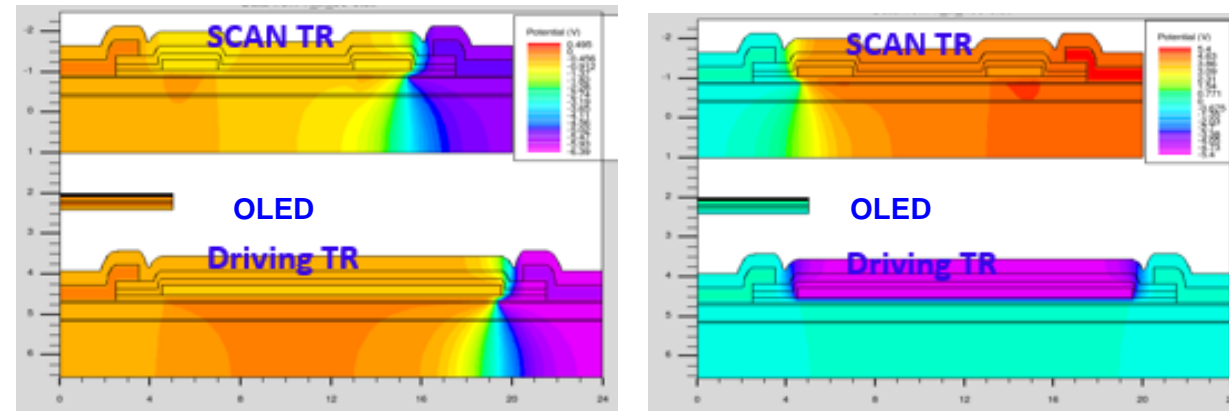

(a) Time=5µs

Potential Map

(b) Time=46µs

Resolve Image Retention, Sticking, Aging, and Hysteresis Issues

Silvaco Proprietary 4-Terminal TFT Model

- Single model to explore display design decisions
- More accurate and true to how the TFT functions
- Provides a modeling advantage for display design
- Adopted in a wide range of technologies

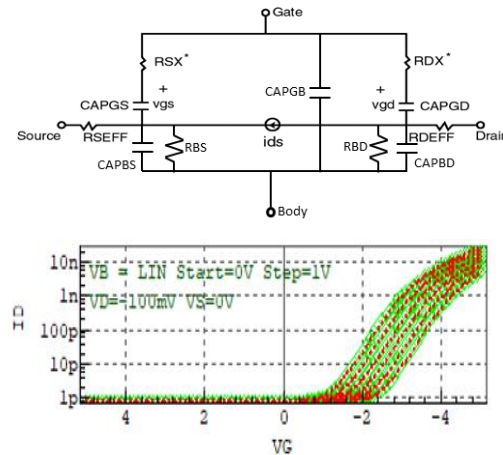
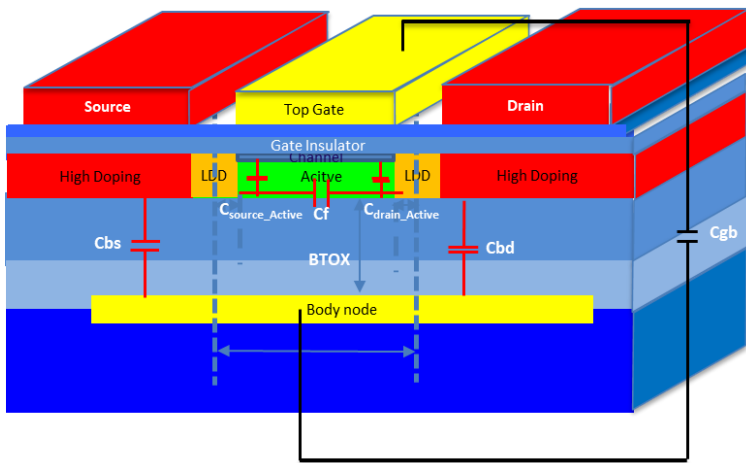

SmartSpice Unique Flex Modeling

- Enables simulation of dynamic modeling effects
- Helps resolve image quality issues
- Display designers can now resolve image quality issues at simulation time
- Unique solution, only available in SmartSpice

Image retention, sticking, persistence, residual image

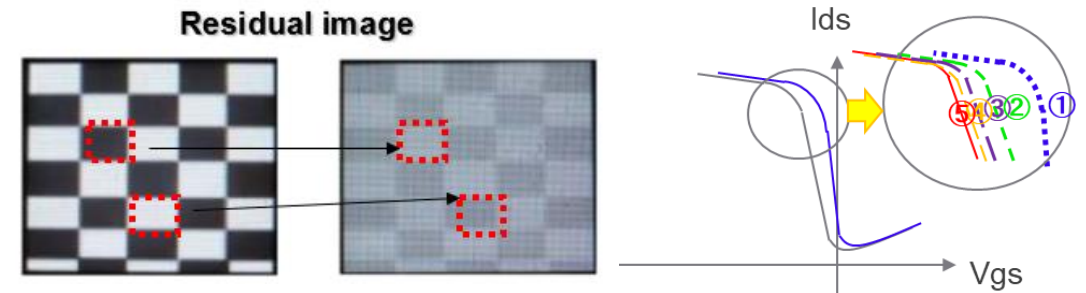

High Accuracy and Flexible Spice Model Generation

Connect Technology to Design

- **Flexible Extraction Strategy**

- A variety of optimization algorithms, enabling flexible strategies for parameter extraction such as Differential Evolution, Genetic Algorithm, Hooke-Jeeves' Hybrid, Levenberg-Marquardt, Parallel Tempering, Simulated Annealing
- This flexible strategy enables designers obtain better fitting results even for strange curves that are difficult to extract with a deterministic strategy used in other tools

- **TFT Compact Models**

- RPI Amorphous-Si TFT Model
- RPI polysilicon TFT Model
- Universal Organic TFT Model
- CINVSTAV-URV Metal-Oxide TFT Model
- **4-terminal Silvaco proprietary TFT Model**

- **Verilog-A**

- UTMOST IV supports Verilog-A parameter extraction, widely used in the display industry

Optimization using Rubberbanding

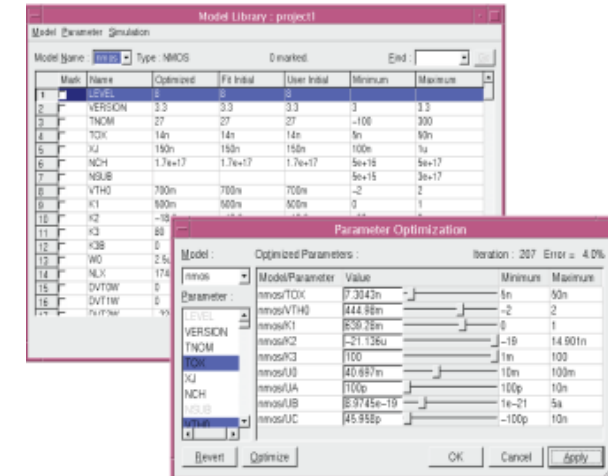

Fitting results for p-Si TFT device

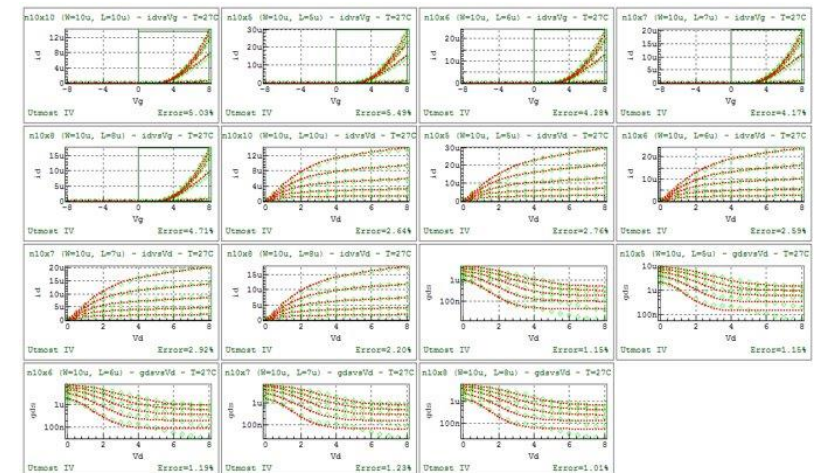

Design and Verification

Smart Design Tools for Flexible Circuit Design

For circuit analysis and optimum design

Gateway + Device Explorer

- Design engineers must understand basic characteristics of the TFT (I-V, C-V, temp., W/L dependent)
- Basic characteristics of the device in a circuit schematic are immediately accessible, and can be explored in simulation

SmartSpice + Rubberbanding

- When co-optimizing of the design and manufacturing processes, trial and error by prototypes is costly
- Slider interface allows investigating circuit performance in real time, changing design and model parameters

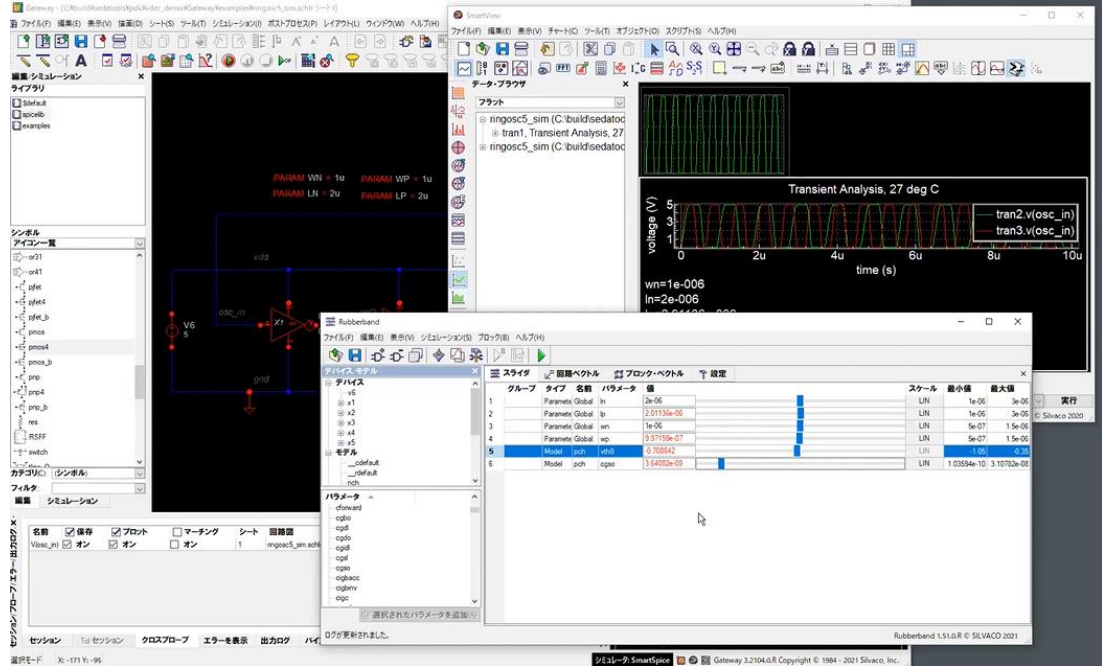
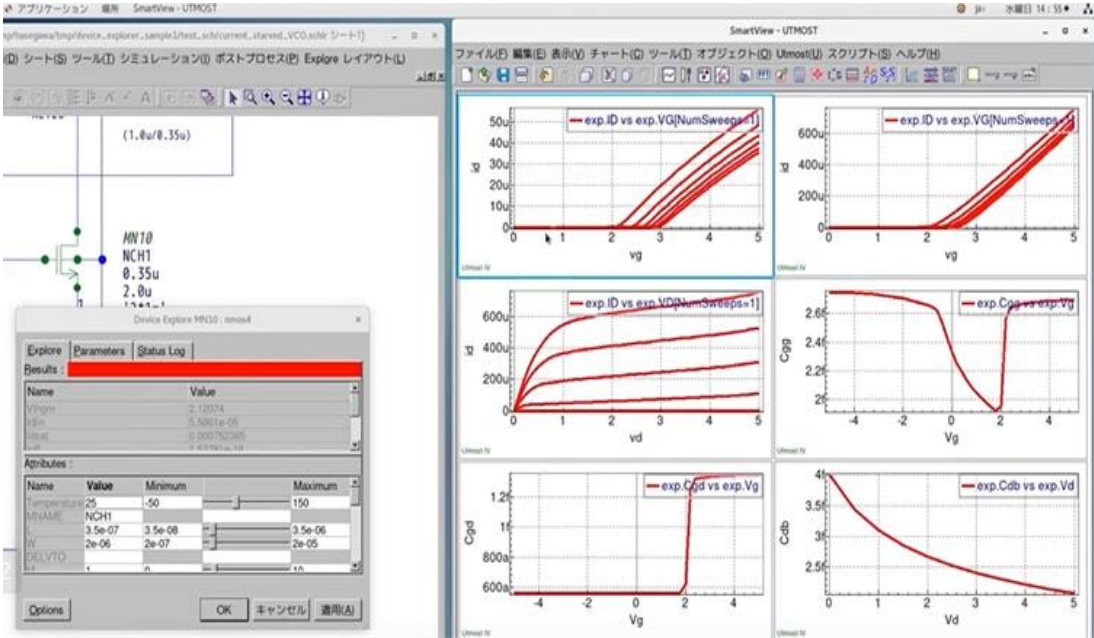

System Level Verification of FPD Products

SmartSpice Signal Integrity

- SmartSpice signal integrity simulations
 - S-Parameter (Touchstone format), W-element, and IBIS
- Simulation model can be developed to check signal transmission quality from the PCB to the display device

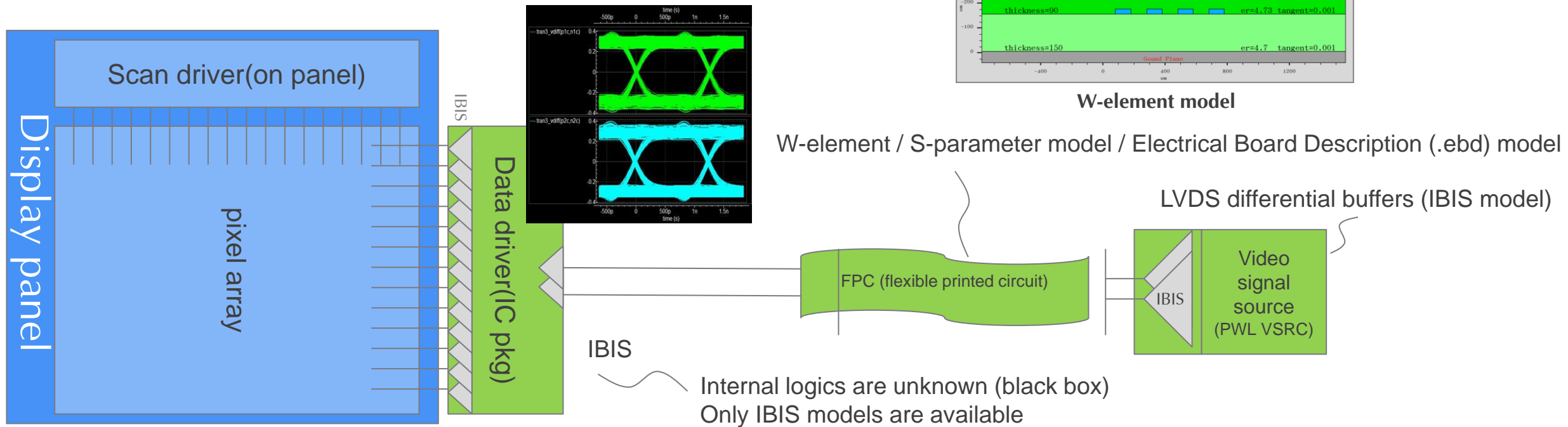

Display Layout Solution with Display Specific Functionality

Expert

- Full feature, custom layout editor
- Integrated design flow for productivity & ease-of-use
- Customizable menus, and GUI - toolbars, panels
- Productivity features
 - DRC Assist, Edit-In-Place, Connectivity highlighting, Short locator, Embedded Layout vs Layout' Cross-sectional Viewer
 - Flat Panel Display Features: Equal-Resistance Router, Route along curve, Pixel with frame, Fan shape connections, Clone wires, Slot wires ...
- OpenAccess and iPDK Support
- Powerful Java scripting capability and API for external control via Python scripts
- DXF file import / export

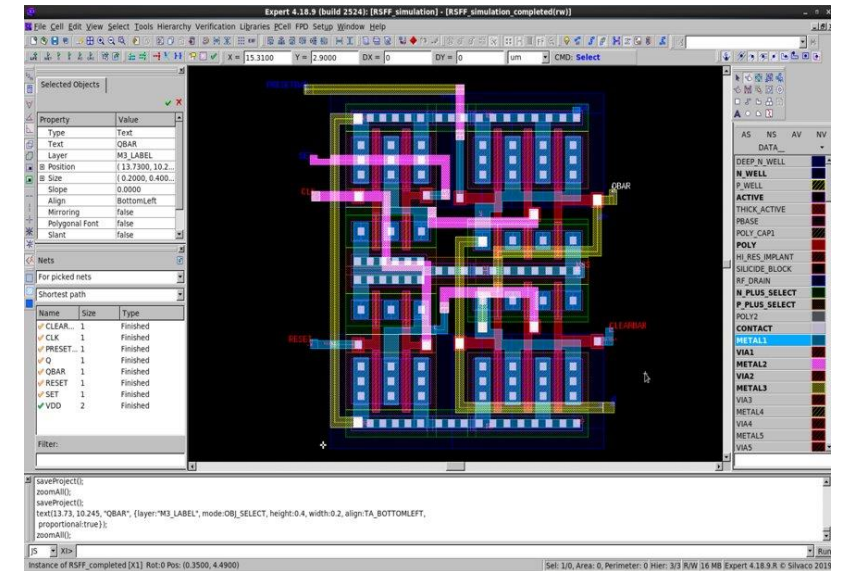

Many FPD features

Smart Array Filtering in DRC

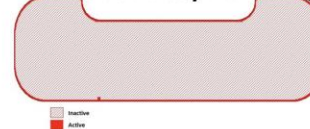

Equal Length Routing



Fan Shaped Connections

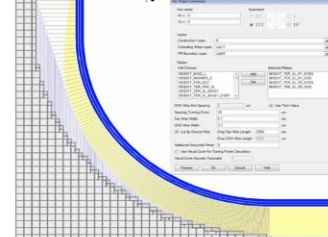

Routing Along Curve

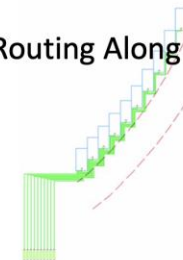

Clone Wires

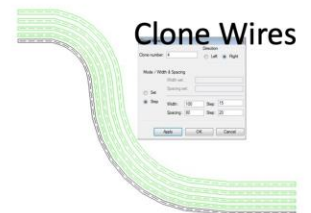

Physics Accurate RC Parasitic Extraction

Victory RCx Pro

- High accuracy
 - Adaptive meshing feature allowing accurate computation of capacitances in pixels on the order of a few femto-farad.
- Covers cell level and full panel
- Easy to Use
 - Graphical user interface developed through many years of collaboration with FPD vendors
 - Victory RCx Pro can be launched directly from Silvaco's Expert layout tool
- LCD Option
 - Support of optical simulation

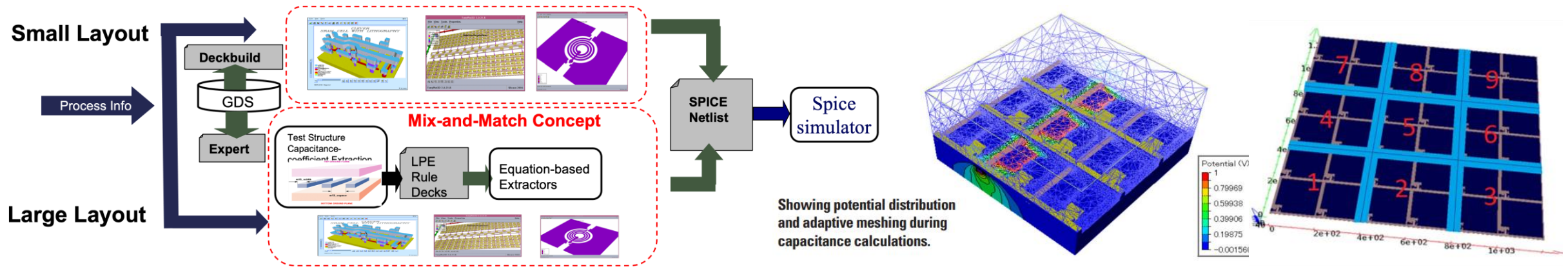

Large Scale Circuit Simulation

SmartSpice Pro

SmartSpice Pro enables large scale circuit simulation within a acceptable computational time

- **Logical verification**
 - Logical verification of driver circuits
 - Detection of simple human errors such as misconnections
- If both layout and circuit schematic are wrong, LVS will pass
- **Full screen simulation**
 - Simulate several hundred million elements of arrayed pixel circuits to check image quality
 - Estimate IR Drop
 - For designs with many RC parasitic elements, reduction by built-in “Jivaro Pro” maintains accuracy while increasing simulation speed

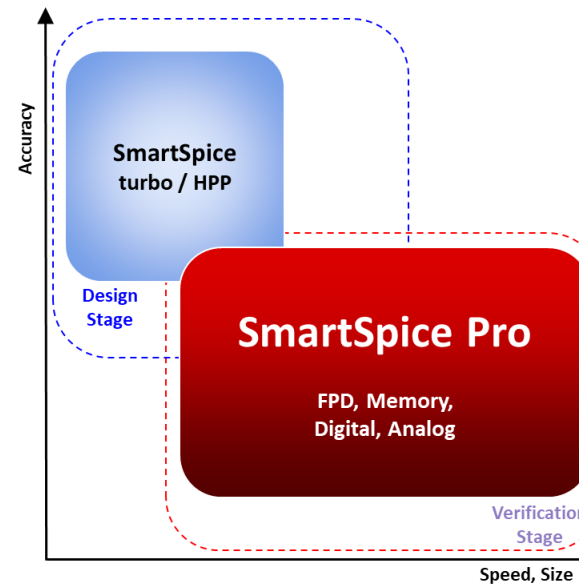

Pulse transfer check in V-driver

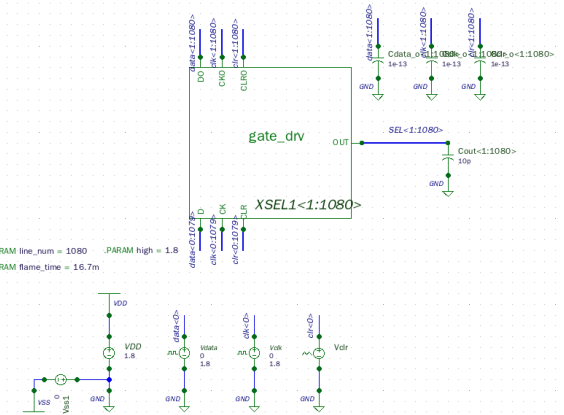

54 Tr / stage x 1080
stage = 58,320 Tr

	Runtime
SmartSpice	9d 14h
SmartSpice Pro	3h 34min

Intel(R) Xeon(R) CPU E5-2667 v3
@ 3.20GHz, 8core, memory : 64 GB

SmartDRC/LVS with SmartRDE

High Speed Physical Verification with Debugger

Highly competitive performance

- The processing speed of Smart DRC is fast and highly scalable to the number of CPU cores
- Particularly suitable for customers who have many CPU cores

DRC Hierarchical Error Report

- In Display, non-orthogonal shapes are frequently used. As a result, many pseudo-errors are generated, and visual confirmation of each error is essential. Highly readable error reports are required
- The “Hierarchical error reporting” feature significantly improves error readability

SmartDRC/LVS Multi-CPU Speedups

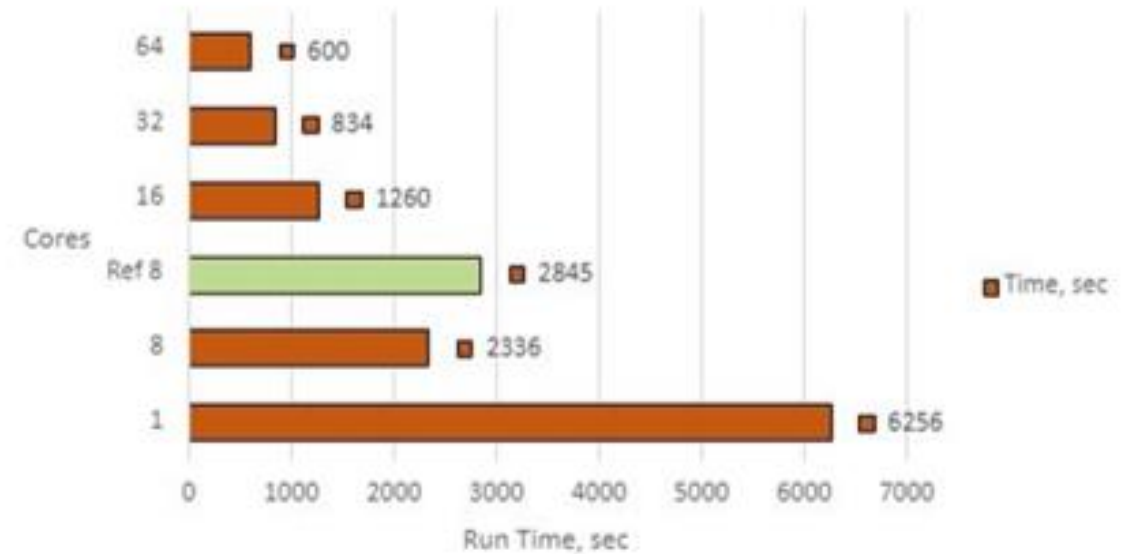

Rule Name	Cell Name	Insts/Level	Flat	In the cell	Layer/Type	Output
as_data.o.v1	PixArrayRGBTop	1/0	179559	0	201/0	
	Tr	179559/4	179559	1		
data.s1	PixArrayRGBTop	1/0	59858	59855	207/0	
	dataLine	1/1	3	3		
data_lto.o.v1	PixArrayRGBTop	1/0	367041	187201	208/0	
	pixrgb_arr_line1	281/1	281	1		
	PixTopB	59853/3	59853	1		
	PixTopG	59853/3	59853	1		
	PixTopR	59853/3	59853	1		
fltr.s1	PixArrayRGBTop	1/0	299265	0	204/0	
	PixRGB	59853/2	119706	2		
	PixTopB	59853/3	59853	1		
	PixTopG	59853/3	59853	1		
	PixTopR	59853/3	59853	1		
fltr.v1	PixArrayRGBTop	1/0	119706	0	203/0	
	PixTopB	59853/3	119706	2		
scan.s1	PixArrayRGBTop	1/0	358905	119493	205/0	
	PixRGB	59853/2	59853	1		
	PixTopB	59853/3	59853	1		
	PixTopG	59853/3	59853	1		
	PixTopR	59853/3	59853	1		
tern2.a1	PixArrayRGBTop	1/0	179559	0	200/0	
	Tr	179559/4	179559	1		
trcont.a1	PixArrayRGBTop	1/0	595118	0	202/0	
	PixTopB	59853/3	59853	1		

Silvaco is leading the way for next generation Display Device Technology development

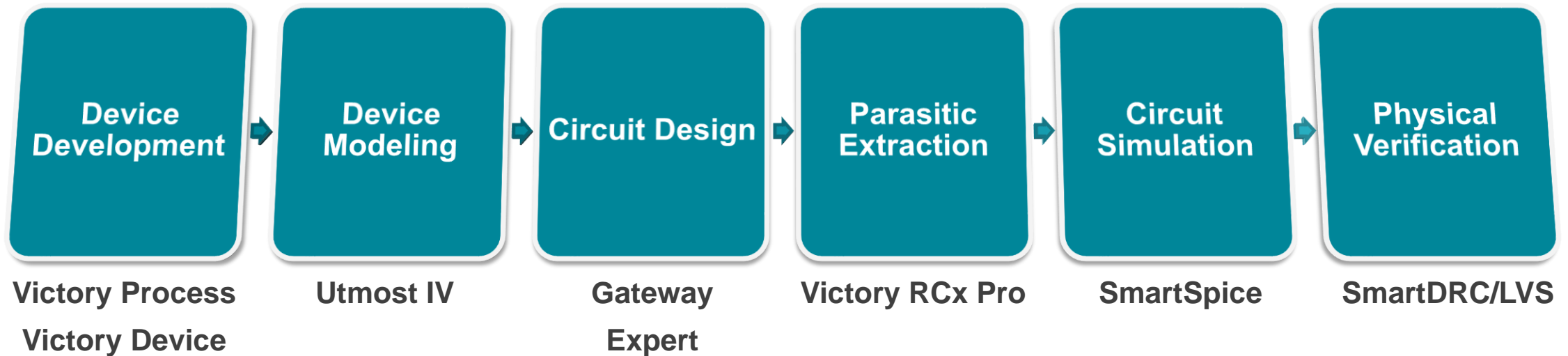

<https://silvaco.com/solutions/display-technology/>

